



roto[®]

agri



roto factories



ROTO is a global producer of high-quality plastic products from polyethylene, polypropylene, polyamide, XPE and ABS with production factories in four European countries. ROTO is a family business company that is presented on the market as a successful manufacturer and reliable business partner for more than 40 years.

ROTO is a leading rotational moulder in Europe with over 4000 different products in range and size up to 70.000L. These products are exported in more than 50 countries all over the world.

ROTO performs all stages of the business process, from product development, product analysing, own tool production, prototype manufacturing, serial production, marketing & sales, distribution and after – sale service. High quality technical products are result of latest production technologies and strong R&D department.

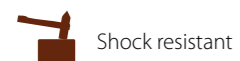

Shock resistant



Families of products: same design and different size



Weather proof and UV rays resistant



Produced according to the EU standards



Very light and easy to handle



Ecological: non toxic and recyclable



Food contact material

4 WHEELBARROWS

23 FEEDERS

28 SILO

34 WINE BARRELS

50 TUBS FOR GRAPES

58 GARDEN FURNITURE

64 SAUERKRAUT CASK

68 VINEGAR, BRANDY BARRELS

77 MEAT TRAYS





Instructions for assembly

No. on drawing	No. of parts
1	1
2	1
3	2
4	1
5	1
6	2
7	2
8	2
9	2
10	2
11	8
12	8
13	8

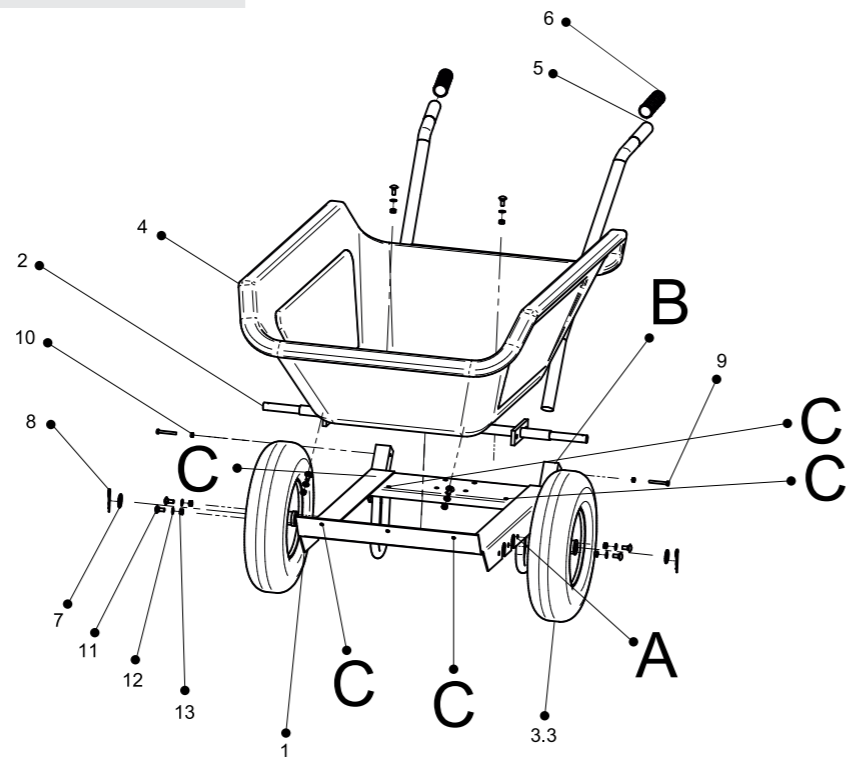

INSTRUCTIONS FOR ASSEMBLY

Instruction for assembly are for next type of Wheelbarrows:
Two wheels Wheelbarrow with galvanized base 250 L, 300 L, 350 L

Necessary tool for assembly:

- Key for nut M8 and M6
- Hammer (weight 300 g)
- Electrical or battery driller and M8 drill

Assembly procedure (please see pictures below):

- bottom of the tray for wheelbarrow must be placed upwards (4)
- tray of the wheelbarrow must be aligned with base of the wheelbarrow (1)
- 4 holes must be drilled on tray (C) with battery driller-drill M8
- 4 screws M8 (11) must be inserted in 4 holes. With hammer we align screws (no space between tray and screws head is allowed)
- washers (12) with nuts M8 (13) must be fastened on the bottom of base
- axis (2) must be inserted on the base (A) and fastened with 4 screws, washers and nuts M8 (11, 12, 13)
- on each side of the axis 2 wheels (3.3) must be positioned and fastened with 2 washers M20 (7). Two safety pins must be inserted (8) on outer side of the wheels
- we flip around wheelbarrow. See picture 4.
- handle (5) must be inserted in to opening (B) and fastened with 2 screws M6X50 (9) and 2 bolts M6 (10)



WHEELBARROWS





FKK TIPPING wheelbarrows

Roto FKK are tipping wheelbarrow which are fitted with a galvanised metal frame, large Polyethylene tray and two pneumatic wheels to deliver superior maneuverability and smooth handling. The massive Polyethylene tray allows you to load up huge volumes of food and waste in your farm. The construction and material used for frame offers durability, strength and a resistance.

Product	Frame	Code	EAN Code	Size [mm]	Wheel
FKK 250 L	galvanized	2100067830	3831116102183	1810 × 910 × 780	4.0-4.8
FKK 300 L	galvanized	2100067940	3831116104668	1820 × 800 × 900	4.0-4.8
FKK 350 L	galvanized	2100067850	3831116102206	1770 × 910 × 830	4.0-4.8
FKK 500 L	galvanized	2100067930	3831116102503	1800 × 900 × 1000	4.0-4.8



HEK TIPPING wheelbarrows

Roto HEK are tipping wheelbarrow which are fitted with a galvanised metal frame, large Polyethylene tray and two pneumatic wheels to deliver superior maneuverability and smooth handling. The massive Polyethylene tray allows you to load up huge volumes of food and waste in your farm. The construction and material used for frame offers durability, strength and a resistance.

Product	Frame	Code	EAN Code	Size [mm]	Wheel
HEK 250 L	galvanized	2100067950	3831116111307	1700 × 860 × 800	4.0-4.8
HEK 300 L	galvanized	2100067960	3831116111314	1700 × 770 × 920	4.0-4.8
HEK 350 L	galvanized	2100067970	3831116111321	1750 × 880 × 850	4.0-4.8
HEK 500 L	galvanized	2100067980	3831116111338	1900 × 900 × 110	4.0-4.8





MFK, MPK TIPPING wheelbarrows

Product	Frame	Code	EAN Code	Size [mm]	Wheel
MFK 350 L	painted	2100067700	3831116112762	1770 × 880 × 910	4.0-4.8
MPK 250 L	galvanized	2100069250	3831116113509	1770 × 870 × 740	4.0-4.8
MPK 350 L	galvanized	2100069270	3831116113523	1600 × 800 × 850	4.0-4.8



2100069270
MPK 350 L



2100067700
MFK 350 L

Roto MFK, MPK are tipping wheelbarrow which are fitted with a galvanised metal frame, large Polyethylene tray and two pneumatic wheels to deliver superior maneuverability and smooth handling. Stable high elastic wheels Ø125mm protect the front rim and enable transport on flat, smooths ground with tilted application. The front rim is amplified with a 1" steel pipe for dumping.

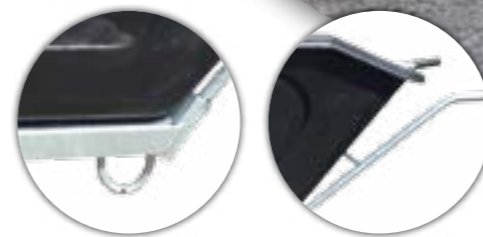

FK2 FARMING wheelbarrows

Product	Frame	Code	EAN Code	Size [mm]	Wheel
FK2 250 L	galvanized	2100067820	3831116102176	1750 × 910 × 700	4.0-4.8
FK2 300 L	galvanized	2100067910	3831116102480	1750 × 910 × 800	4.0-4.8
FK2 350 L	galvanized	2100067840	3831116102190	1950 × 910 × 700	4.0-4.8
FK2 500 L	galvanized	2100067920	3831116102497	2100 × 910 × 900	4.0-4.8

The Roto FK2 is strong farming wheelbarrow that is suitable for use in the stable and yard. Each barrow is fitted with a galvanised metal frame, pneumatic wheels to deliver superior manoeuvrability and smooth handling and Polyethylene tray. They are tough and durable but surprisingly lightweight in use, even with heavy loads.



2100067820
FK2 250 L



2100067910
FK2 300 L



2100067840
FK2 350 L



2100067920
FK2 500 L



LV2, MF2 wheelbarrows

Roto LV2 is the ideal piece of equipment for any heavy duty applications, bringing a hard wearing quality and unrivalled durability, as well as a huge capacity that makes this piece extremely useful.

Product	Frame	Code	EAN Code	Size [mm]	Wheel
LV2 180 L	painted	2100064210	3830010987612	1600 × 800 × 890	3.5-8
LV2 180 L	galvanized	2100064790	3830050771608	1600 × 800 × 890	3.5-8
LV2 200 L	painted	2100066290	3831116108291	1600 × 810 × 910	3.5-8
LV2 200 L	galvanized	2100066280	3831116108284	1600 × 810 × 910	3.5-8
MF2 250 L	galvanized	2100067990	3831116112755	1600 × 820 × 810	4.0-4.8
LV2 250 L	painted	2100066420	3830050778638	1600 × 860 × 850	3.5-8
LV2 250 L	galvanized	2100066430	3830050778645	1600 × 860 × 850	3.5-8
LV2 300 L	painted	2100064180	3830050773596	1600 × 750 × 930	3.5-8
LV2 300 L	galvanized	2100065270	3830050774098	1600 × 750 × 930	3.5-8
LV2 350 L	painted	2100066440	3830050778652	1680 × 870 × 860	3.5-8
LV2 350 L	galvanized	2100066450	3830050778669	1680 × 870 × 860	3.5-8



2100064790 LV2 180 L 2100066280 LV2 200 L 2100067990 MF2 250 L



2100066420 LV2 250 L 2100064180 LV2 300 L 2100066440 LV2 350 L



FKT trailers

Product	Frame	Code	EAN Code	Size [mm]	Wheel
FKT 250 L	galvanized	2100067860	3831196102213	1450 × 910 × 660	4.0-4.8
FKT 300 L	galvanized	2100067870	3831116102220	1500 × 910 × 750	4.0-4.8
FKT 350 L	galvanized	2100067880	3831116102237	1550 × 910 × 700	4.0-4.8
FKT 500 L	galvanized	2100067890	3831116102466	1700 × 910 × 900	4.0-4.8

Trailers are very robust thanks to their metallic chassis and strong trays. The Roto FKT-trailers with 3 wheels and with a massive tub are ideal to load up huge volumes of food in your farm. Fitted with a swivel wheel makes Roto FKT Trailers excellent for manoeuvrability and control.



2100067860 FKT 250 L 2100067870 FKT 300 L



2100067880 FKT 350 L 2100067890 FKT 500 L





Product	Frame	Code	EAN Code	Size [mm]	Wheel
LV1 40 L	paint	2100092420	3831116108321	1200 × 480 × 500	3.0-4
LV1 60 L	paint	2100064710	3830010982396	1370 × 560 × 600	3.5-8
LV1 60 L	galvan	2100164710	3830010982396	1370 × 560 × 600	3.5-8
LV1 80 L	paint	2100064950	3830010982402	1370 × 610 × 720	3.5-8
LV1 80 L	galvan	2100066980	3831116103982	1370 × 610 × 720	3.5-8
LV1 120 L	paint	2100064700	3830050776375	1300 × 750 × 770	3.5-8
LV1 120 L	galvan	2100064000	3830010982389	1300 × 750 × 770	3.5-8
LV1 180 L	paint	2100064780	3830010984581	1460 × 840 × 860	3.5-8
LV1 180 L	galvan	2100064010	3830050774074	1460 × 840 × 860	3.5-8
LV1 200 L	paint	2100066310	3831116108307	1480 × 770 × 840	3.5-8
LV1 200 L	galvan	2100066270	3831116108277	1480 × 770 × 840	3.5-8
LV1 300 L	paint	2100064170	3830050773589	1570 × 750 × 850	3.5-8
LV1 300 L	galvan	2100065260	3830050774081	1570 × 750 × 850	3.5-8

LV1 wheelbarrows

The Roto LV1 are well-known ROTO one-wheel wheelbarrows in the agriculture industry. The wheelbarrow is available with painted or galvanized frame. The trays are made of Polyethylene in capacity from 40 litre.

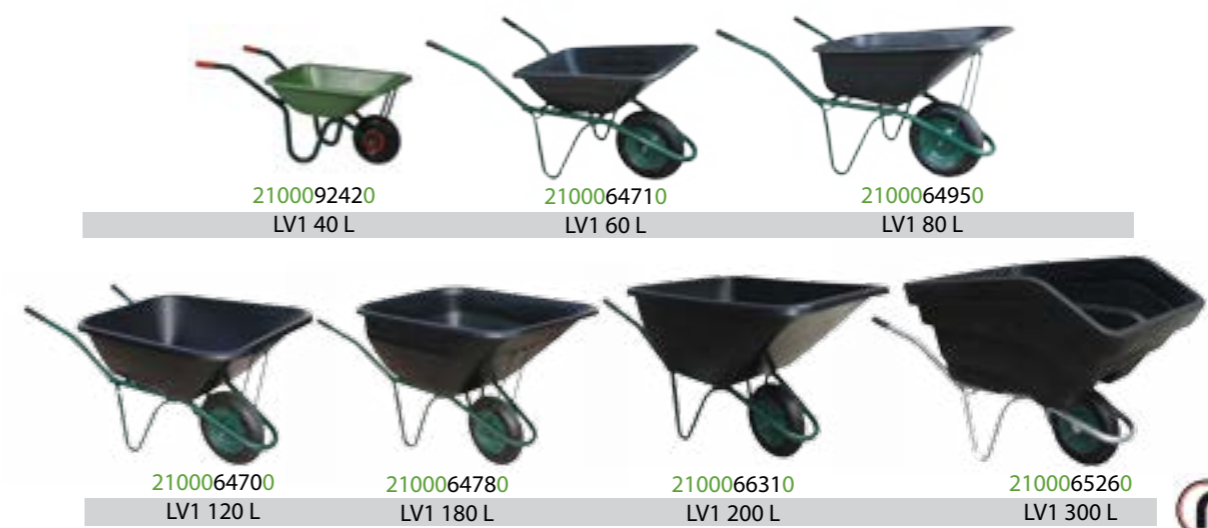



TNT wheelbarrows

Product	Frame	Code	EAN Code	Size [mm]	Wheel
TNT1 120 L	galvanized	2100069280	3831116113530	1600 × 700 × 650	4.0-4.8
TNT1 200 L	galvanized	2100066240	3831116116364	1600 × 770 × 840	4.0-4.8
TNT2 120 L	galvanized	2100069282	3831116113530	1600 × 700 × 650	4.0-4.8
TNT2 200 L	galvanized	2100066222	3831116117392	1600 × 770 × 840	4.0-4.8

The Roto TNT are one-wheeled wheelbarrows in unasssembled version, which are suitable to send per Post. They are easy to assemble.



2100069280
TNT2 120 L

2100066240
TNT1 200 L



Moto wheelbarrows

Motobarrow through having its leading wheel driven by an electric motor is ideal for carrying heavy or bulky material. It functions perfectly well in numerous domestic and industrial conditions, it will work well in difficult terrain including up or down hill slopes. Motobarrow makes load manipulation much easier than standard wheel barrow's, its 12 volt lead battery is safe to use with no danger of electrical spillage.

Additional equipment: charger for battery

Product	Frame	Code	EAN Code	Size [mm]	Wheel
MOTO 120 L	painted	2100066970	3831116103999	1650 × 820 × 750	4.0-4.8
MOTO 200 L	painted	2100066960	3831116104002	1500 × 730 × 620	4.0-4.8
MOTO 500 L	painted	2100069260	3831116113516	2070 × 900 × 870	4.0-4.8



2100066970
MOTO 120 L

2100066960
MOTO 200 L



2100069260
MOTO 500 L





HAY & DUNG carts

Product	Frame	Code	EAN Code	Size [mm]	Wheel
Hay cart	galvanized	2100069240	3831116113493	980 × 1550 × 500	4.0-4.8
Dung cart	galvanized	2100069290	3831116113820	980 × 1550 × 500	4.0-4.8
MF Dung shovel	painted	2100069230	3831116113813	620 × 180 × 800	150 × 40



2100069240
Hay cart

2100069290
Dung cart

2100069230
MF Dung shovel



MT TIPPING trailer

- Usage: in the farm for the machines which do not go by the high way
- Extremely roomy bowl with plastic
- Frame powder coated, color: black.
- Bowl fold - function dump.
- Articulated drawbar coupling ball.
- Pneumatic wheels 600-8 with robust axle and roller bearings.
- Maximum used 25 km/h
- Maximum load 250 kg

Product	Frame	Code	EAN Code	Size [mm]	Wheel
MT tipping trailer 300 L	painted	2100067540	3831116116371	1670 × 770 × 910	600-8
MT tipping trailer 500 L	painted	2100067520	3831116112991	1800 × 840 × 950	600-8



2100067540
MT tipping trailer 300 L

2100067520
MT tipping trailer 500 L





TRAYS for wheelbarrows

standard color

● black

special colors

min. order of 20 pcs

- green ● orange
- pink ● red
- blue ● grey

Product	Code	EAN Code	Size [mm]	PCS/pallet
40 L	2100094800	3831116108253	800 × 550 × 250	60
60 L	2100064730	3830010980200	800 × 550 × 250	60
70 L	2100094820	3831116113226	860 × 570 × 290	60
75 L	2100094830	3831116113233	860 × 570 × 290	60
80 L	2100064740	3830010981702	800 × 550 × 300	60
120 L	2100064750	3830010982372	1040 × 750 × 450	40



2100094800
40 L



2100064730
60 L



2100094820
70 L



2100094830
75 L



2100064740
80 L



2100064750
120 L

TRAYS for wheelbarrows

Product	Code	EAN Code	Size [mm]	PCS/pallet
180 L	2100064770	3830010984598	1040 × 750 × 300	40
200 L	2100066330	3831116106679	1150 × 760 × 430	40
250 L	2100066400	3830050778478	1250 × 820 × 430	20
300 L	2100064400	3830050773169	1170 × 770 × 530	10
350 L	2100066410	3830050778621	1400 × 820 × 450	20
500 L	2100066340	3831116102152	1610 × 820 × 710	10

- Advantages of Polyethylene trays:
- Lightweight
 - Easy in use and self assembly
 - Simple to clean
 - Durable (wallthickness 3-6 mm)
 - Stabilized against UV rays and frost
 - 100% recycle after use



2100064770
180 L



2100066330
200 L



2100066400
250 L



2100064400
300 L



2100066410
350 L



2100066340
500 L



HORSE equipment

JUMP BLOCK - it's a high quality product made from polyethylene with options to put tubes barriers on each sides Excellent for building cavaletties, training jumps, parallels, cross poles and ground lines. They are designed to use singly or stacked.

MOUNTING step it's a high quality product made from polyethylene and has a three steps. On the back is a handle for easy transfer and storage cabinet. Perfect for traveling to shows, camping or around the house or barn.

colors:

- green
- orange
- yellow
- pink
- red
- grey
- blue

Product	Code	EAN Code	Size [mm]
Jump block	2100586000	3830050776788	610 × 385 × 230
Mounting step	2100586010	3831116112588	797 × 678 × 606
Mounting step with storage cabinet	2100586020	3831116112595	797 × 678 × 606



2100856000
Jump block



2100586010
Mounting step



2100586020
Mounting step with storage cabinet



SNACK ball

The Snack-a-Ball is the perfect companion for conscientious owners as it encourages horses to mimic natural grazing behaviour, which is beneficial to their digestion. It also helps horses to stretch forwards and down, which may enhance their muscle tone and flexibility. Good all-round suitability.

colors:

- green
- orange
- yellow
- pink
- red
- blue

Product	Code	EAN Code	Size [mm]
Snack ball	2100512930	3830043917464	Ø30
Ball for hay type FR	2100512870	3831116118955	Ø40
Ball for hay type OKI	2906204060	3858883812015	Ø40



2100512930
Snack ball



2100512870
Ball for hay type FR



2906204060
Ball for hay type OKI



WILD tray

Universal plastic tray for transport of wild animals are made of durable material. The bottom of tray has reinforcit ribbs which help to slide when we use tray in the snow. Size that fits in trunk.

Product	Code	EAN Code	Size [mm]
Wild tray PT 70 L	2100513430	3831116105528	790 × 585 × 165
Wild tray 63 L	2100065310	3830010982327	790 × 575 × 180
Wild tray 80 L	2100065300	3830010982334	970 × 630 × 230
Wild tray PT 100 L	2100513440	3831116105535	1070 × 630 × 220



21000513430
Wild tray PT 70 L

2100065300
Wild tray 80 L



21000513440
Wild tray PT 100 L



FEEDERS





FEEDERS, WATERERS

The durable polyethylene rectangular feeders are suitable for feed chicken, turkey, pigs, ... Waterer for chicken take up little space. All feeders and waterers are also from strong, durable material – it cannot break, lightweight, simple to clean and stabilized against UV rays and frost.

Product	Code	EAN Code	Size [mm]
Feeder for chicken	2100065220	3830010980194	Ø400 × 350
Feeder for turkey	2100065370	3830010981559	Ø600 × 370
Waterer for chicken	2100065230	3830010980187	Ø330 × 310
Feeder for chicken	2106124060	3858883813661	Ø456 × 50
Waterer for chicken	2106125060	3858883813678	Ø250 × 240
Feeder S	2100065000	3830010982273	470 × 440 × 180
Feeder M	2100065200	3830010982280	440 × 680 × 180
Feeder L	2100065210	3830010982297	440 × 1000 × 180
Chain feeder	2100065530	3830010981597	980 × 380 × 200



2100065220
Feeder for chicken



2100065370
Feeder for turkey



2100065230
Waterer for chicken



2106124060
Feeder for chicken



2106125060
Waterer for chicken



2100065000
Feeder S



2100065200
Feeder M



2100065210
Feeder L



2100065530
Chain feeder



WALL feeders

Product	Code	EAN Code	Size [mm]
Manger with hooks	2100065350	3830010981603	380 × 320 × 360
Wall manger	2100065360	3830010981610	490 × 370 × 300
Corner manger	2100078000	3830010989654	600 × 410 × 240
Feeder for animals	2100065280	3830010981580	300 × 780 × 160
Feeder for swine	2100065250	3830010982303	160 × 300 × 350
Feeder for pig	2100065240	3830010982310	300 × 760 × 520

Roto feeders for horses are made of durable polyethylene material. Cornered manger are very convenient, because take up a little space in corner. All feeders and mangers are simple to clean and stabilized against UV rays and frost.



2100065350
Manger with hooks



2100065360
Wall manger



2100078000
Corner manger



2100065280
Feeder for animals



2100065250
Feeder for swine



2100065240
Feeder for pig





HAY & GRAINS containers

Product	Code	EAN Code	Size [mm]
Hay feeder 200 L	2100061240	3830010983683	900 × 700 × 540
Trailer 200 L with cover type MFT, 2 wheels	2100067900	3831116102473	1100 × 900 × 800
Container 200 L with cover	2100061240	3830010983683	900 × 700 × 540
Container 300 L with cover	2100061230	3830010983256	950 × 740 × 640
Container 400 L with cover	2100061200	3830010983225	1090 × 750 × 800
Container 700 L with cover	2100061210	3831116108659	1200 × 800 × 700



2100067900
Trailer 200 L



2100061240
Container
with chambers

2100061240
Container
with front hole

2100061240
Container
without front hole

2100061240
Hay feeder
200 L



Haybell

Product	Code	Volume [L]	Size [mm]
Haybell	2105209250	3000	Ø1750 × 1500

Designed to fit over a standard round bale this product protects hay in all weather conditions and minimizes wastage due to trampling or fouling. It also delivers superior nutrition retention by minimizing nutrient loss from exposure to weather.

- With 3 openings



2105209250
Haybell





SILO

Silo is intended to store feeding stuff, grain, briquettes, flour, etc.

It is a one piece polyethylene pantry and constructed in a way to easily support the weight of stored material.

PLACING

Silo can be placed under a roof or can stand outside. It should be placed on flat, reinforced concrete slab (at least 10 cm thick and in size of 4 x 4 m). To prevent silo from overturning, it should also be bolted onto the slab.

FILLING

The silo can be filled through an opening at top or through filling pipe. When the material is inside a silo, the lid should be closed. Silo can be filled automatically over filling pipe (additional accessory).

EMPTYING

Can be discharged through the opening at the bottom of the silo. It is also possible to install your own screw snail at the place of use.

TECHNICAL CHARACTERISTICS

The silo is intended to store food and is made of polyethylene. The material assures you the best characteristics for storing and provides long-term use. The inner side of the silo is covered with paraffin, which prevents material from sticking on the walls. Thick walls provide excellent thermal insulation and prevent accumulation of condensation. The silo construction ensures water resistance and easy cleaning. Contents of the silo remain dry, no matter if it is placed in the open. This is important to ensure excellent quality materials.



SILO



SEGMENTS silo

This is a freestanding silo. It serves to store clover, ground maize, maize grain, sugar beet pulp, grain, flour, coffee and sawdust. This is the best solution for farmers who have lower daily material removal. This way the removal of segments does not cause subsequent fermentation and spoilage of material. When a segment is empty, we can remove it and ensure a better access to content.

Product	Code	EAN Code	Size [mm]
Silo segment Ø1100 with a bottom	2100063400	3830010983409	Ø1100 × 1000
Silo segment Ø1100 without a bottom	2100063500	3830010983508	Ø1100 × 1000
Silo segment Ø1800 with a bottom	2100063370	3830010989821	Ø1800 × 700
Silo segment Ø1800 without a bottom	2100063380	3830010989838	Ø1800 × 700
Cover Ø1800 for segment silo	2100063390	3830050770328	Ø1800
Silo segment Ø2000 with a bottom	2100063420	3830010983423	Ø2000 × 1000
Silo segment Ø2000 without a bottom	2100063520	3830010983522	Ø2000 × 1000
Conical head Ø2000 for silo	2100063450	3830010983454	Ø2000
Opening Ø250 for SILO segment	2100064100	3831116105542	Ø250



FeSILO

with metal construction

The silo is intended to store food and is made of polyethylene. The material assures you the best characteristics for storing and provides long-term use. The inner side of the silo is covered with paraffin, which prevents material from sticking on the walls. Thick walls provide excellent thermal insulation and prevent accumulation of condensation. The silo construction ensures water resistance and easy cleaning. Contents of the silo remain dry, no matter if it is placed in the open. This is important to ensure excellent quality materials.

Product	Code	EAN Code	Size [mm]
FeSILO 1 m ³ (plastic+metallic socle+opening)	2100072990	3830050771479	1230 × 1030 × 1800
FeSILO 3 m ³ (plastic+metallic socle+opening)	2100063430	3830010983430	Ø1800 × 2150
FeSILO 10 m ³ (plastic+metallic socle+opening)	2100063490	3831116116616	Ø2000 × 4900
FeSILO 15 m ³ (plastic+metallic socle+opening)	2100063550	3830010984277	Ø2000 × 6850
Add. equipment B metallic filling tube with ventilation	2100064190	3830050774104	-
Add. equipment C B+ metallic tube with ladder and safety ring	2100064080	3830050774067	-





RoSILO free standing



opening



stairs

screw
conveyorsfilling
pipe

TECHNICAL CHARACTERISTICS

- Since it is a one-piece model, it is 100% waterproof and prevents moisture from leaking into the silo.
- Polyethylene Roto silo has 12 – 14 mm wall thickness, which provide excellent thermal insulation. Thus, the silo will maintain its inside temperature even if outside temperatures change rapidly.
- Smooth walls prevent sticky materials from sticking to the wall.
- The silo weights just over 300 kg. Its weight allows

easy placement and transportation. It is well balanced so it doesn't need to be installed on concrete floor.

- Due to freestanding form, its mobility is excellent. The silo can easily be moved from one place to another.
- Roto's 10m³ silo is only 4,2 m high, so it can be placed inside an outbuilding.
- Silo has a long lifetime. Wall thickness, great statics and UV polyethylene stability. After this the silo can be 100% recycled.



RoSILO free standing

USE

Silo is intended to store feeding stuff, grain, briquettes, flour, etc. It is a one piece polyethylene pantry and constructed in a way to easily support the weight of stored material.

EQUIPMENT

- Silo has security gate, screw conveyors and filling pipe, which are made of corrosion resistant material.
- There are two openings at the top of the silo.

Ø800 mm, where a filling pipe diameter (110 mm) is placed, and the second (Ø 500 mm) for insight into the silo.

- Both openings are covered with cover which are waterproof sealed. Therefore the silo can be placed outdoors. There are also outflow doors for manual material removal at the bottom of it.
- Possible filling through vacuum or pleasure pump.
- Roto provides complete solution for silos.



Product	Code	EAN Code	Size [mm]
RoSILO 10 m ³ self standing with transporter	2100063470	3830050770892	Ø2330 × 4000
RoSILO 10 m ³ self standing without transporter	2100163470	3830050770892	Ø2330 × 4000
RoSILO 15 m ³ self standing with transporter	2100063530	3830050770908	Ø2330 × 5000
RoSILO 15 m ³ self standing without transporter	2100163530	3830050770908	Ø2330 × 5000



Golden medal on the AGRA Fair.





WINE barrels

Parafined wine barrels for fermentation and storage of most, wine, cider and brandy.

ADVANTAGES

- long lifetime,
- the good quality of the wine contained,
- an attractive wine cellar,
- easy and fun cellaring,
- easy to carry because of its light weight,
- good thermal insulation,
- keeps wine at a constant temperature,
- the flat bottom enables easy transportation,
- due to its good thermal isolation, the polyethylene barrels keep wine at a constant temperature
- fermentation and storage conditions are like in wooden barrel,
- UV-stabilised polyethylen, food safe,
- produced in rotation moulding, without welding points,
- flat areas for mounting fittings.

MAINTENANCE

- plug on the cover is removed when fermentation tub is installed,
- clean the paraffin walls of the barrels with cold water,
- sulphurate the barrels with stick on the long wire or with a liquid sulphur,
- due to the large openings the barrels are easy to clean,
- barrels over 100 L have 2 spigots.

ACCESSORIES



Certificate for food contact material



Label with instructions for use in your language

WINE barrels





BARIK wine barrels

Parafined wine barrels for fermentation and storage of most, wine, cider and brandy. The inside wall of polyethylene barrel is covered with paraffin wax. Fermentation and storage conditions are like in wooden barrel.

Product	Code	EAN Code	Size [mm]	Cover diameter
Barik 3 L	2100061950	3830050776085	Ø130 × 180	plug
Barik 10 L	2100068480	3831116119938	Ø260 × 270	Ø140
Barik 13 L	2100068490	3831116119945	Ø250 × 310	Ø140
Barik 23 L	2100061940	3831116102596	Ø310 × 400	Ø140
Bag in box 23 L	2100070490	3830043913411	Ø310 × 400	Ø140
Barik 30 L	2100062600	3830010987766	Ø320 × 440	Ø140
Barik 50 L	2100062650	3830010987858	Ø380 × 440	Ø140
Barik 100 L	2100062610	3830010987773	Ø450 × 700	Ø140



BARIK wine barrels

Parafined wine barrels for fermentation and storage of most, wine, cider and brandy. The inside wall of polyethylene barrel is covered with paraffin wax. Fermentation and storage conditions are like in wooden barrel. Additional equipment: plug with screw for upper hole.

Product	Code	EAN Code	Size [mm]	Cover diameter
Barik 150 L	2100062620	3830010987780	Ø550 × 600	Ø140
Barik 200 L	2100062630	3830010987841	Ø660 × 830	Ø140
Barik 350 L	2100062640	3830010988718	Ø700 × 1100	Ø240
Barik 500 L	2100062670	3830010988725	Ø800 × 1150	Ø240





CLASSIC wine barrels

On the front side is wine image, on the top is mounted lid, seal and fermentation tub.

The inside wall of polyethylene barrel is coated with paraffin. Fermentation and storage conditions are like in wooden barrel.

Product	Code	EAN Code	Size [mm]	Cover diameter
Classic 10 L	2100062220	3830010981825	250 × 220 × 300	Ø140
Classic 25 L	2100062160	3830010982808	300 × 400 × 300	Ø140
Classic 40 L	2100062100	3830010982419	410 × 500 × 310	Ø140
Classic 80 L	2100062110	3830010982426	520 × 600 × 380	Ø240
Classic 180 L	2100062120	3830010982433	850 × 700 × 600	Ø240
Classic 260 L	2100062130	3830010982440	950 × 770 × 880	Ø240



2100062220
Classic 10 L



2100062160
Classic 25 L



2100062100
Classic 40 L



2100062110
Classic 80 L



2100062120
Classic 180 L



2100062130
Classic 260 L



MOST wine barrels

Parafined wine barrels for fermentation and storage of most wine, cider and brandy. The inside wall of polyethylene barrel is covered with paraffin wax.

Product	Code	EAN Code	Size [mm]	Cover diameter
Most 50 L	2100062400	3830010982488	Ø420 × 540	Ø140
Most 120 L	2100062410	3830010986240	Ø520 × 680	Ø240
Most 240 L	2100065870	3830050774111	Ø700 × 860	Ø240
Most 360 L	2100065880	3830050774135	Ø800 × 1070	Ø240



BAG in BOX

Bag in box is container for the storage and transport of liquids. Put the bag in plastic barrel and install the original tap in it. Liquids will stay without connection with air in the bag. Additional equipment: cooler from stainless steel.



2100062400
Most 50 L

2100062410
Most 120 L

2100065870
Most 240 L

Bag in box



ECO cider barrels

Eco horizontal barrels for storage and fermentation of cider. Cider from apples is made from pressed apples. The juice or must is fermented with yeast to produce an alcoholic beverage usually around 6% abv. Apple cider can be made with the addition of the unprocessed juice from the fruit of a small, indigenous tree known as Speierling.

Product	Code	EAN Code	Size [mm]	Cover diameter
Eco 50 L	2100062200	3830010980255	380 × 560 × 400	Ø240
Eco 100 L	2100062210	3830010980262	450 × 700 × 550	Ø240
Eco 200 L	2100062290	3830010980279	540 × 740 × 530	Ø240
Eco 300 L	2100062300	3830010981856	610 × 890 × 880	Ø240
Eco 500 L	2100062240	3830050770526	800 × 870 × 1000	Ø400



2100062200 Eco 50 L 2100062210 Eco 100 L 2100062290 Eco 200 L 2100062300 Eco 300 L 2100062240 Eco 500 L



COGNAC wine barrels

Barrels are suitable for storage brandy, cognac, liqueur, wine, apple cider or others.

Product	Code	EAN Code	Size [mm]	Cover diameter
Cognac 30 L	2101101260	3858883816594	Ø350 × 460	Ø170
Cognac 50 L	2101102260	3858883816495	Ø400 × 550	Ø170
Cognac 80 L	2101103260	3858883816501	Ø470 × 590	Ø170
Cognac 120 L	2101104260	3858883816525	Ø580 × 625	Ø170
Cognac 160 L	2101105260	3858883816532	Ø630 × 685	Ø170
Cognac 200 L	2101106260	3858883816563	Ø650 × 800	Ø170
Cognac 330 L	2101107030	3858883813760	Ø800 × 870	Ø170



2101101260 Cognac 30 L 2101102260 Cognac 50 L 2101103260 Cognac 80 L 2101104260 Cognac 120 L

2101105260 Cognac 160 L 2101106260 Cognac 200 L 2101107030 Cognac 330 L



STEELY wine tanks

Vertical wine tanks are excellent for storage and fermentation of wine by professional wine producer. Tanks are excellent imitation of stainless steel tanks, but because of wallthickness 5-8 mm they are better by temperature isolation. Equipment: plastic cover 400 mm, oval opening from stainless steel, out flows DN 50 mm.

Product	Code	EAN Code	Size [mm]
Wine tank 1000 L	2100062280	3830010981870	Ø1000 × 1800
Wine tank 2000 L	2100062310	3830010981894	Ø1120 × 2200
Wine tank 5000 L	2100062490	3830010982495	Ø1800 × 2200



2100062280
Wine tank 1000 L



2100062310
Wine tank 2000 L



2100062490
Wine tank 5000 L



BUCKET for carry grapes

Polyethylene carrying tube is light and easy to carry, easy to clean and maintain. They are available in bright colors. Small buckets are used by children at grape harvesting.

Product	Code	EAN Code	Size [mm]
Bucket 5 L	2100091820	3831116113134	280 × 185 × 310
Bucket 10 L	2100064900	3830010984437	300 × 200 × 300
Bucket 15 L	2101108260	3858883818680	168 × 287 × 399
Bucket 20 L	2100064890	3830010981962	400 × 300 × 400
Bucket 25 L	2101002060	3858883816587	207 × 355 × 507

Bucket 40 L	2100064880	3830010980217	480 × 330 × 500
Bucket 45 L	2100091890	3830010987049	500 × 320 × 610
Bucket 50 L	2101001060	3858883813722	340 × 200 × 645
Bucket 60 L	2100064820	3830010980095	530 × 370 × 640



2100091820 Bucket 5 L 2100064900 Bucket 10 L 2101108260 Bucket 15 L 2100064890 Bucket 20 L 2101002060 Bucket 25 L



2100064880 Bucket 40 L 2100091890 Bucket 45 L 2101001060 Bucket 50 L 2100064820 Bucket 60 L



BUCKET for carry grapes

Polyethylene bucket for carrying grapes in imitation of wood. Light and easy to carry, easy to clean and maintain. Small carrying tube is ideal for children when they participate at wine events.

Product wood effect	Code	EAN Code	Size [mm]
Bucket 10 L	2100068190	3831116120644	300 × 300 × 200
Bucket 25 L	2100091850	3830050774975	420 × 390 × 260
Bucket 60 L	2100064830	3830050770885	580 × 490 × 330



2100068190
Bucket 10 L

2100091850
Bucket 25 L

2100064830
Bucket 60 L

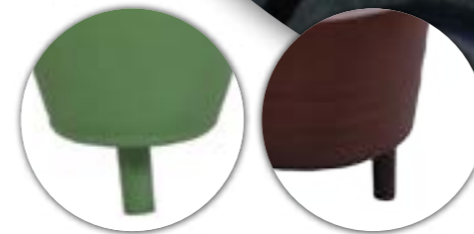

FUNNELS for wine

Tubs, baskets and funnels are made of polyethylene, are lightweight, easy to clean, UV stable, 100% recycle after the use.

Product	Code	EAN Code	Size [mm]
Funnel	2100064800	3830010980125	370 × 150 × 290
Funnel 20 L	2101003060	3858883812800	520 × 370 × 280
Funnel 25 L	2100064860	3830010982686	Ø300 × 350
Funnel 30 L	2101004060	3858883810103	600 × 430 × 390
Funnel 40 L	2100064810	3830010980118	Ø450 × 540



2100064800
Funnel



2101003060
Funnel 20 L



2100064860
Funnel 25 L



2101004060
Funnel 30 L



2100064810
Funnel 40 L



FDA tanks

Storage tanks LTV and FDA are cylindrical vertical tanks with a large screw lid, inserted litre scale and flat spots for mountings. The FDA are made of "LLD-PE (low-linear density polyethylene) and is chemically resistant, UV- stabilized and food safe. This type is absolutely seamless with a smooth inner surface and has a high wall thickness.

Product	Code	EAN Code	Size [mm]
FDA 35 L	2100513020	3830010987797	Ø323 × 500
FDA 60 L	2100513090	3830010987803	Ø420 × 620
FDA 60 L	2100513120	3830043919024	Ø420 × 600
FDA 75 L	2100513130	3830043919031	Ø450 × 610
FDA 100 L	2100513140	3830043919048	Ø450 × 760
FDA 200 L	2100513160	3830043919055	Ø550 × 990
FDA 300 L	2100513180	3830043919062	Ø660 × 1040
FDA 500 L	2100513660	3830043919147	Ø770 × 1240



2100513020 FDA 35 L 2100513090 FDA 60 L 2100513130 FDA 75 L 2100513140 FDA 100 L 2100513160 FDA 200 L 2100513180 FDA 300 L 2100513660 FDA 500 L

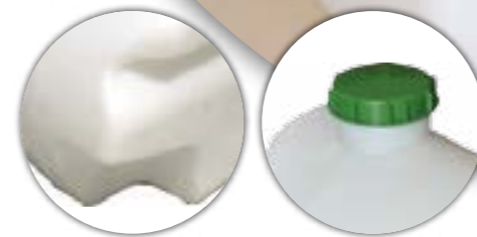

TCW tanks

The series TCW are horizontal tanks are suitable for water. The TCW has a large screw lid, for an easy filling and flat spots for transport. ROTO dosing tanks are produced seamless in a rotation moulding process made of high quality polyethylene. They have a high wall thickness and a smooth inner surface. Color of the tank is clear white.

Product	Code	EAN Code	Size [mm]
TCW 40 L	2100526300	3830010987254	440 × 380 × 410
TCW 70 L	2100526360	3830010984246	600 × 470 × 430
TCW 100 L	2100526400	3830010987261	690 × 500 × 460
TCW 150 L	2100526460	3830010987292	580 × 640 × 630
TCW 200 L	2100526500	3830010984253	750 × 640 × 640
TCW 300 L	2100527960	3830010984307	920 × 700 × 710
TCW 500 L	2100527940	3830010984260	1170 × 780 × 840
TCW 750 L	2100765300	3830010983126	1170 × 980 × 1000
TCW 1000 L	2100527090	3831116116791	1200 × 1180 × 1160

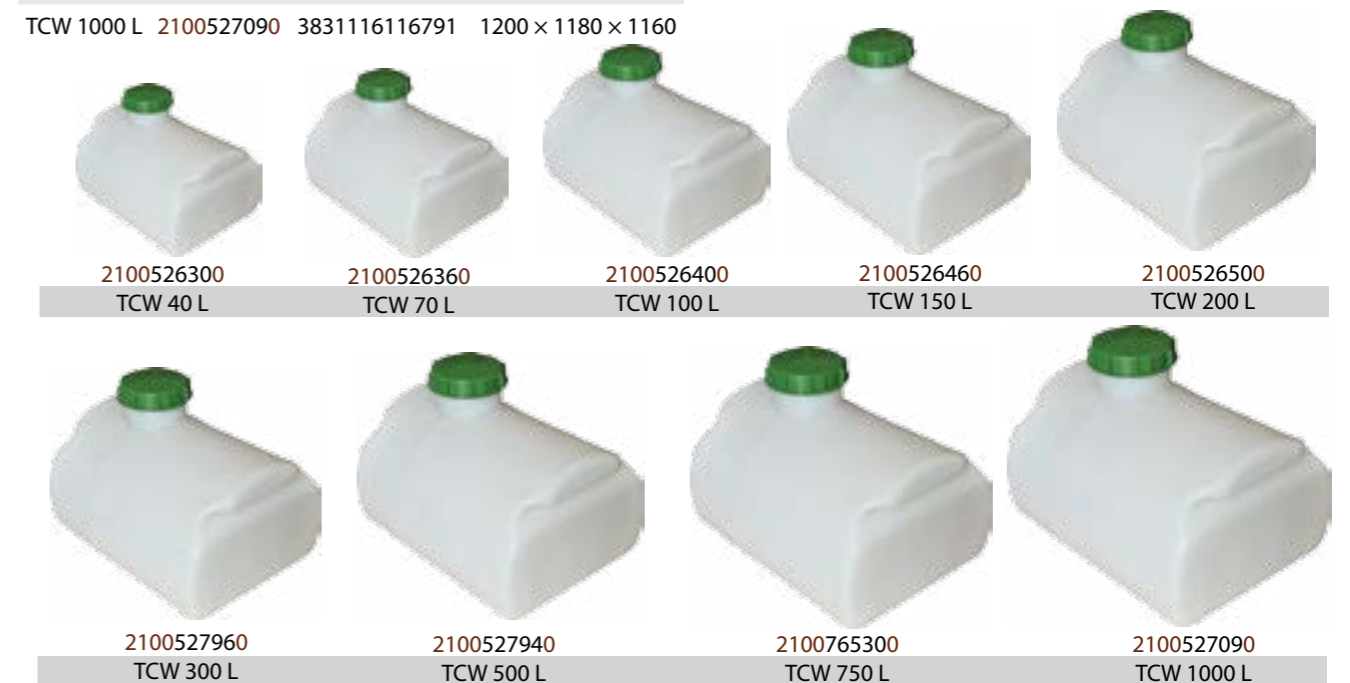

2100526300 TCW 40 L 2100526360 TCW 70 L 2100526400 TCW 100 L 2100526460 TCW 150 L 2100526500 TCW 200 L
2100527960 TCW 300 L 2100527940 TCW 500 L 2100765300 TCW 750 L 2100527090 TCW 1000 L





OTW tanks

The series OTW are rectangular horizontal tanks, which are suitable for storage and transport of water, wine, brandy and other liquids. The OTW has a large screw lid, for an easy filling. ROTO dosing tanks are produced in a rotation moulding process made of high quality polyethylene. The standard color of the tanks is clear white.

Product	Code	EAN Code	Size [mm]
OTW 150 L	2100511750	3830010984161	720 × 470 × 710
OTW 200 L	2100511770	3830010984178	800 × 500 × 750
OTW 300 L	2100511800	3830010984192	940 × 570 × 865
OTW 500 L	2100518830	3830010984239	1350 × 550 × 970



2100511750
OTW 150 L

2100511770
OTW 200 L

2100511800
OTW 300 L

2100518830
OTW 500 L



BEER barrels

Product	Code	EAN Code	Size [mm]
Beer barrel 30 L	2100062010	3830050771790	Ø360 × 440
Beer barrel 50 L	2100062040	3830050771806	Ø370 × 610



2100062010
Beer barrel 30 L

2100062040
Beer barrel 50 L



TUBS and harvest CONTAINERS

The durable polyethylene square tubs are suitable for transport and storage of grapes and other. Reinforced edge of the tube allows it to install a mill to grind fruit.

Round conical tubs can be used for storage and transport of fruit. They could be stackable when are not in use.

Safe, durable and eco friendly harvest plastic containers will help you to save on maintenance costs, space and storage.

ADVANTAGES

- Long-lasting,
- the good quality of the grapes contained,
- an attractive wine cellar,
- easy and fun cellaring,
- easy to carry because of its light weight,
- the flat bottom enables easy transportation,
- easy maintenance,
- easy filling through a large opening,
- the inside wall of polyethylene tub is flat.



eco friendly -
possible to recycle
100% after use

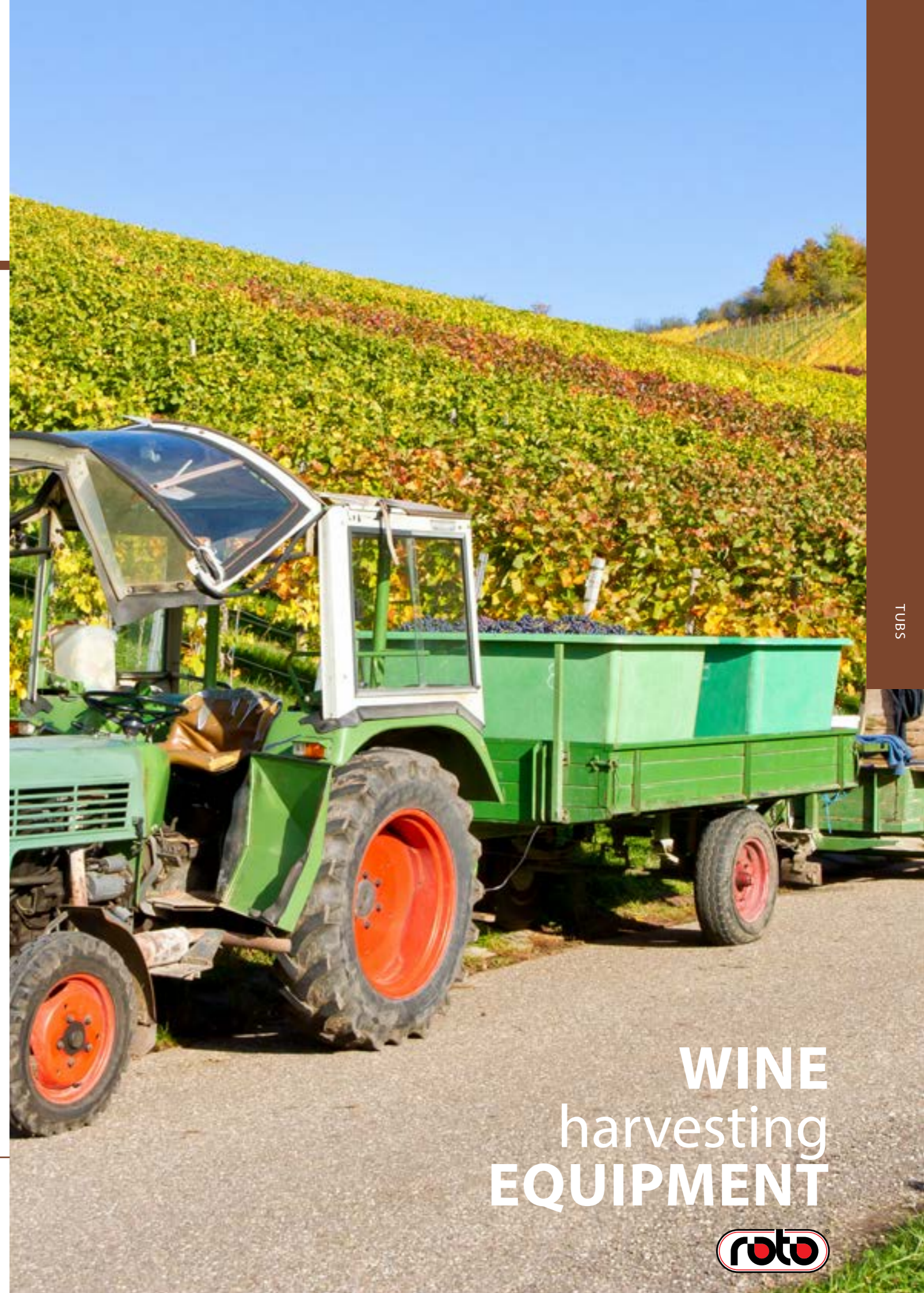

WINE
harvesting
EQUIPMENT





ROUND tubs

Round conical tubs can be used for storage and transport of fruit. The possibility of white tub provides a hygienic integrity and transparency above the level of content.

Product	Code	EAN Code	Size [mm]
100 L	2101010260	3831116113240	Ø680 × 465
175 L	2101011260	3831116113257	Ø850 × 650
250 L	2101012260	3830010980033	Ø905 × 720
350 L	2101013060	3830010980057	Ø1020 × 720
500 L	2101014260	3831116113271	Ø1160 × 780
600 L	2101015060	3830010980088	Ø1060 × 1150
750 L	2101016060	3830010980088	Ø1300 × 880
1000 L	2101017260	3830010980088	Ø1450 × 940



2101010260
Tub 100 L



2101012260
Tub 250 L



2101016060
Tub 750 L



2101017260
Tub 1000 L



ROUND tubs with covers

Product	Code	EAN Code	Size [mm]
120 L	2100063020	3830010980026	Ø740 × 510
180 L	2100063030	3830010980033	Ø860 × 560
250 L	2100063040	3830010980040	Ø950 × 620
350 L	2100063050	3830010980057	Ø980 × 780
500 L	2100063060	3831116105559	Ø1050 × 840

Cover for tub:

Product	Code	EAN Code	Size [mm]
120 L	2100063100	3830010980248	Ø740 × 50
180 L	2100063110	3830010980286	Ø860 × 50
220 L	2100063170	3830010980842	Ø1220 × 50
250 L	2100063120	3830010980293	Ø950 × 50
350 L	2100063130	3830010980309	Ø980 × 50
500 L	2100063140	3830010980316	Ø1050 × 50

Waterproof cover (pour the water into gutter). We can install tap into the tube for outflow.



2100063030
Tub 180 L



2100063050
Tub 350 L



2100063060
Tub 500 L



SCHALLOW tubs

Round conical tubs can be used for storage and transport of fruit. Little tubs are also available in special shapes and colors (imitation of wood).

Product	Code	EAN Code	Size [mm]
Tub 60 L	2101006060	3858883812213	Ø710 × 240
Tub 90 L	2101007060	3858883812886	Ø780 × 260
Tub 135 L	2101008060	3858883812220	Ø920 × 300
Tub 220 L	2100063000	3830010980231	Ø1220 × 330
Woody 25 L	2100062890	3830010988077	Ø400 × 200
Woody 75 L	2100062870	3830010987735	Ø570 × 300
Woody 110 L	2100062880	3830010988091	Ø670 × 320
Woody 210 L	2100062910	3830010988398	Ø800 × 420



2101006060
Tub 60 L

2101007060
Tub 90 L

2101008060
Tub 135 L

2100063000
Tub 220 L



2100062890
Woody 25 L

2100062870
Woody 75 L

2100062880
Woody 110 L

2100062910
Woody 210 L



SQUARE tubs

Product	Code	EAN Code	Size [mm]
100 L	2100061070	3830010980347	670 × 880 × 320
200 L	2100061120	3830010980354	700 × 900 × 540
400 L	2100061180	3830010980385	750 × 950 × 640
500 L	2100061160	3830010980392	820 × 1210 × 810
500 L pallet	2100061170	3830010981818	820 × 1210 × 810

The durable polyethylene rectangular tubs are suitable for transport and storage of grapes and fruit. Reinforced edge of the tube allows it to install under the grinding mill machine. The bottom of the tube can also be a pallet shape, which allows transport with a forklift. The tubs with a lower height can be used also for collecting must/wine below the wine press. Rectangular tubs take up little space and can be stacked one into another.



2100061070
Tub 100 L

2100061120
Tub 200 L

2100061160
Tub 500 L

2100061170
Tub 500 L pallet



HARVEST containers

Product	Code	EAN Code	Size [mm]
220 L	2100062960	3830050774036	1000 × 630 × 400
240 L	2100061150	3830010980361	1100 × 630 × 400
300 L	2100061110	3830010985403	1300 × 630 × 560
300 L	2100061140	3830010980378	950 × 740 × 640
340 L	2100062970	3830050774043	1510 × 630 × 400
400 L	2100061180	3830010980385	950 × 750 × 640
460 L BP	2100075830	3830050770717	-



2100062960 Container 220 L 2100061150 Container 240 L 2100061110 Container 300 L



2100062970 Container 340 L 2100061180 Container 400 L 2100075830 Container 460 L





GARDEN furniture

Rattan furniture such as chairs and tables are made of high quality polyethylene and they are the most reliable, comfortable and cost-effective option.

Using plastic outdoor furniture, in a garden or courtyard, on a balcony / terrace or elsewhere, enables you to take full advantage of the sunshine, while being assured that your outdoor plastic furniture is weather resistant (acts of nature are not covered).

This outdoor plastic furniture has been designed in a rattan style, making it just as attractive as traditional rattan outdoor furniture while being stronger, easier to clean, and waterproof.

ROTO rattan outdoor furniture is available either as an outdoor plastic patio furniture set, or as individual plastic chairs and tables to suit the needs of every customer.

ADVANTAGES

- long lifetime,
- an attractive wine cellar, garden,...
- easy and fun cellaring, gardening,...
- easy to carry because of its light weight,
- the flat bottom enables easy transportation.

USE

- for indoor and outdoor use (wine cellars and garden),
- gastro and private use,
- UV stability,
- easy maintenance,
- easy drying, protection from decay and easy transport,
- nice shape: ROTO-plastic furniture in wood design will give your wine cellar, garden or... a special flair. The furnitures are lightweight and are therefore easy to transport,
- guaranteed quality,
- light weight,
- wood effect,
- easy to clean.

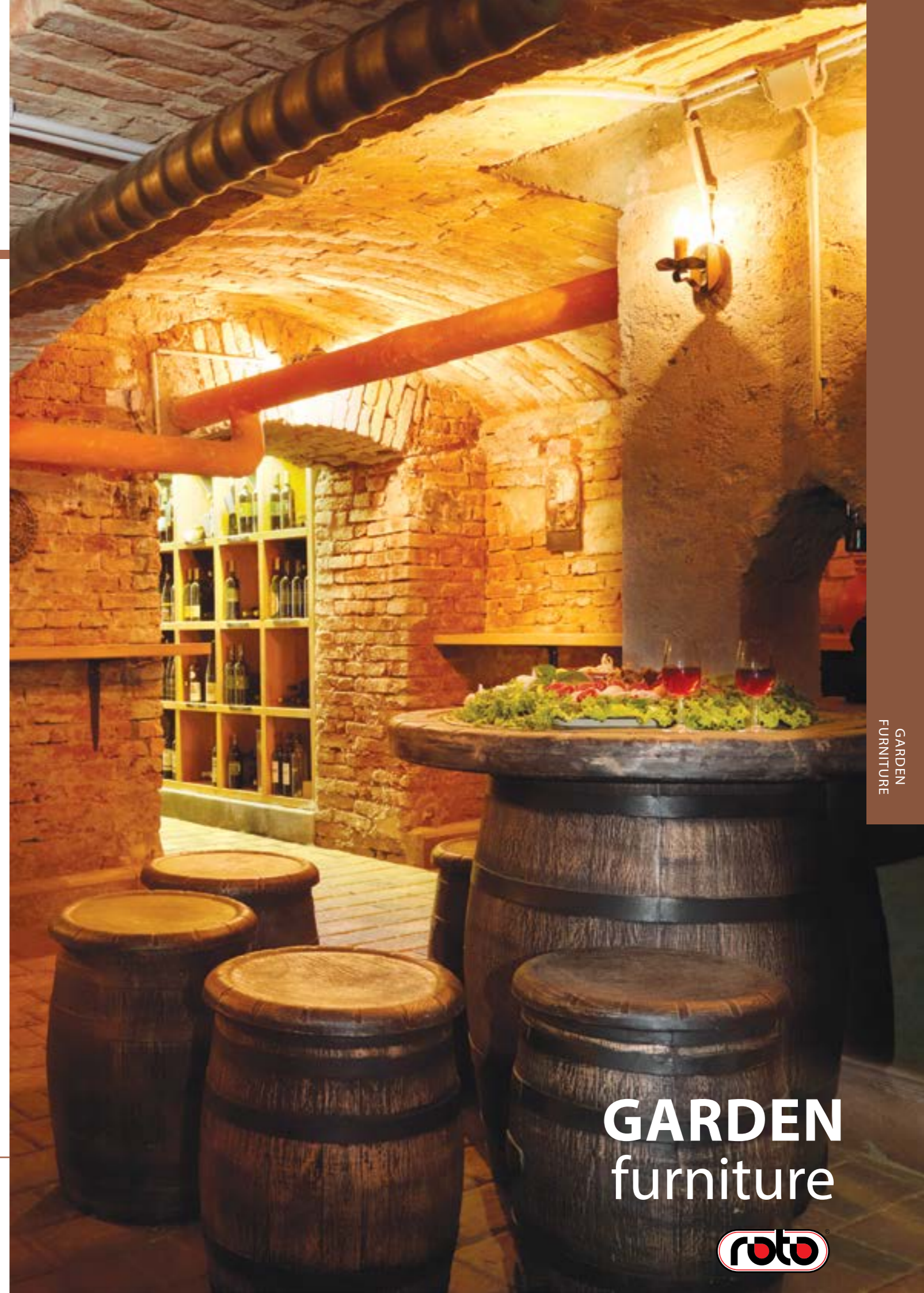

GARDEN
furniture





GARDEN furniture

Tables and chairs in barrel design

- for indoor and outdoor use (wine cellars and garden)
- gastro and private use
- UV stability
- easy to clean, easy maintenance
- light weight
- wood effect

Product	Code	EAN Code	Size [mm]
Chair in barrel design	2100062860	3830010982877	Ø400 × 550
Table in barrel design	2100062850	3830010982853	Ø1000 × 900



2100062860
Chair in barrel design



2100062850
Table in barrel design



GARDEN furniture

Tables and chairs in barrel design

- for indoor and outdoor use (wine cellars and garden)
- gastro and private use
- UV stability
- easy to clean, easy maintenance
- light weight
- wood effect

Product	Code	EAN Code	Size [mm]
Bar chair in barrel design	2100096500	3831116101698	Ø420 × 760
Bar table in barrel design	2100062840	3830050770946	Ø1000 × 1300



2100096500
Bar chair in barrel design



2100062840
Bar table in barrel design



GARDEN furniture

Rattan furniture such as chairs and tables are made of high quality polyethylene and they are the most reliable, comfortable and cost-effective option. Using plastic outdoor furniture, in a garden or courtyard, on a balcony / terrace or elsewhere, enables you to take full advantage of the sunshine, while being assured that your outdoor plastic furniture is weather resistant (acts of nature are not covered).

ROTO rattan outdoor furniture is available either as an outdoor plastic patio furniture set, or as individual plastic chairs and tables to suit the needs of every customer.

Product	Code	EAN Code	Size [mm]
Chair rattan	2100096010	3830043912735	750 × 810 × 650
Table rattan	2100096000	3830050772162	Ø690 × 490
Table rattan	2100096020	3831116106686	Ø760 × 680



2100096010
Chair rattan



2100096000
Table rattan



2100096020
Table rattan



GARDEN basins

Product	Code	EAN Code	Size [mm]
Sink mars	2100066110	3831116102268	400 × 620 × 730
Sink dioniz	2100061000	3830010986110	250 × 480 × 720
Tub for milk vessel cleaning	2100064480	3830010984345	730 × 600 × 355
Tub for milk vessel cleaning	2100064480	3830010984345	730 × 600 × 355



2100066110
Sink mars



2100061000
Sink dioniz



2100064480
Tub for milk vessel cleaning



2100064480
Tub for milk vessel cleaning



SAUERKRAUT cask

Natural souring of various vegetables is the oldest method of preservation, as it was already used by ancient Egyptians. In this method of storage allows lactic acid to develop during souring, which gives the vegetable s their durability.

ADVANTAGES

The vegetables do not need to be washed. You can also sour other vegetables in the cask: Bulgarian salad, sauerkraut, Serbian cabbage, turnips, red beats, pickles, peppers, ... We include recipes so that the salad will be healthy, natural and homemade. By using ROTO cask, you are saving time and energy for canning, space in the cellar, and your vegetables will be stored in a sanitary way.

Storage vegetables in a Roto cask and eat delicious salad in the winter

SAUERKRAUT

The cabbage needs to be in good condition and completely clean for souring. Preserve the graded cabbage as soon as possible. Use spices such as: salt, pepper, bay leaf, cumin, horseradish, and hot peppers. Press the cabbage evenly so that the cabbage juice fully covers it. The cabbage should be salted evenly so that it does not release too much juice. The best temperature for souring is between 17 C and 22 C. When the souring is finished (in 4 to 5 weeks), store the cabbage at 10 C. When you take the cabbage out of the container, make sure that it stays covered with juice.

“SARMA ”

Turn the cabbage head so that the stalk is pointing upwards. Cut around the stalk at an angle until you have cut it off. Remove a few more leaves by cutting off the thicker part of the cabbage head. Slice the remainder of the cabbage head into thin slices. Mix cooled sautéed onion with smoked meat and raw ground meat into half cooked, cooled rice. Add salt and pepper, and add a pinch or two of marjoram, chopped parsley, ground sweet pepper, and an egg. Cover the bottom of the pot with smoked pork and graded sour cabbage. Wrap the cabbage rolls, place them in the pot, and put the cabbage stalk in the middle. Cover everything with the remainder of the sour cabbage. Pour in boiled water (approx. 1,5 l). Cover with a lid and cook for approximately one hour.



Certificate for food contact material

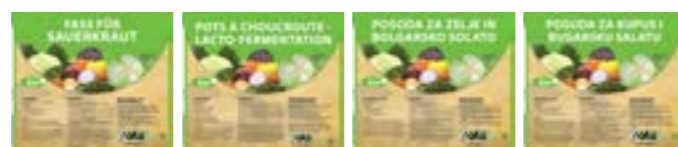

Label with instructions for use in your language



SAUERKRAUT cask





SAUERKRAUT cask

Product	Code	EAN Code	Size [mm]
Cask 15 L	2100062060	3830010981283	Ø300 × 350
Cask 25 L	2100064600	3830010980224	Ø300 × 420
Cask 30 L	2100096300	3831116113202	Ø300 × 460
Cask 40 L	2100064120	3830010988749	Ø380 × 420
Cask 50 L	2100064610	3830010980156	Ø400 × 670
Cask 60 L	2100096310	3831116113219	Ø405 × 460
Cask 80 L	2100064140	3830010987056	Ø450 × 530
Cask 90 L	2101211060	3858883812343	Ø545 × 740



Product	Code	EAN Code	Size [mm]
Cask 100 L	2100064620	3830010980163	Ø550 × 750
Cask 120 L	2100064150	3830010988626	Ø530 × 615
Cask 150 L	2100062090	3830010985540	Ø650 × 810
Cask 200 L	2100064630	3830010980170	Ø670 × 860
Cask 250 L	2101212060	3858883812350	Ø525 × 900
Cask 300 L	2100064160	3830050774005	Ø640 × 910



SAUERKRAUT cask



VINEGAR barrels

Vinegar can be medicinal, especially when it is prepared at home in the natural way. Homemade vinegar accelerates the metabolism, slows aging, helps maintain body weight, prevents the formation of fat cells, and promotes clean and glowing skin, nails and hair.

ADVANTAGES

- The vinegar will maintain the same quality
- ROTO vinegar barrels are cone-shaped, which enables the vinegar mother to grow uninterrupted and cover the whole surface of the vinegar.
- The vinegar will maintain the same level of concentration
- ROTO vinegar barrels can be sealed by pouring water into the rim of the barrel and then placing the lid on top. As a result, the vinegar does not evaporate.
- The barrels have a spigot at the bottom where the vinegar can be poured out.
- The barrels come with recipes on how to easily prepare vinegar.

HOW to prepare vinegar?

PREPARATION OF APPLE CIDER VINEGAR

- 10 kg apples (washed, crushed or sliced)
- 20 l warm water
- 8 dag yeast (2 cubes), 1 l beer, 0.5 kg sugar

Mix the ingredients in a ROTO vinegar barrel. Remove the lid from the barrel and cover the opening with gauze. Place the barrel in the sun for a few weeks (at T=25-30 C) until the apple juice ferments.

Mixing with old vinegar (acetic fermentation): In the ROTO vinegar barrel, the vinegar will ferment from sugar into alcohol, and afterwards into acetic acid. After the sugar has fermented for two weeks, pour 0.5 l of old vinegar into the barrel. After a few more weeks, strain the vinegar. Vinegar mother will form on the surface, which is a natural protection for the vinegar and floats on top of it.

PREPARATION OF VINEGAR FROM WINE

- Place the WINE into a vinegar barrel and leave it in a warm place for 8 days.
- When you notice that there is acetic fermentation, pour in water and add old vinegar.
- Let it acidify at approximately 25 C, and enable fresh air to flow inside.
- After a few months, strain the vinegar into the opening of the barrel and seal it with the lid.
- The vinegar mother always needs to stay on the vinegar's surface.
- Pour water into the rim of the ROTO barrel and cover it with the lid.
- The barrel can be used for the production and storage of vinegar.
- Do not transport the barrel while there is vinegar inside, as the vinegar mother will sink and ruin the flavour of the vinegar.



Certificate for food contact material



Label with instructions for use in your language



VINEGAR barrels





VINEGAR barrels

ROTO vinegar barrels can be sealed by pouring water into the channel of the barrel and then placing the lid on top. As a result, the vinegar does not evaporate.

- The vinegar barrels have a spigot at the bottom.
- A recipe and instructions how to make apple or wine vinegar at home.

Product	Code	EAN Code	Size [mm]
15 L	2100061290	3830050773152	Ø380 × 320
25 L	2100062050	3830010981290	Ø380 × 420
50 L	2100062030	3830010981948	Ø470 × 500
75 L	2100065980	3831116102336	Ø490 × 630
100 L	2100062020	3830010981955	Ø580 × 600
200 L	2100062080	3830010985397	Ø700 × 800



2100061290 15 L 2100062050 25 L 2100062030 50 L 2100065980 75 L 2100062020 100 L 2100062080 200 L



BACKERY vessels with handles

Product	Code	EAN Code	Size [mm]
Transport box 30 L	2100064320	3830010981481	400 × 500 × 180
Transport box 45 L	2100064310	3830010981498	420 × 500 × 270
Transport box 60 L	2100061850	3830050774616	420 × 500 × 300
Transport box 75 L	2100064300	3830010981658	420 × 500 × 400
Vessel for knead dough 40 L	2100064450	3830010982259	440 × 1000 × 200
Vessel for knead dough 100 L	2100064460	3830010982266	580 × 1200 × 260



2100064320 Transport box 30 L 2100064310 Transport box 45 L 2100061850 Transport box 60 L 2100064300 Transport box 75 L



2100064450 Vessel for knead dough 40 L 2100064460 Vessel for knead dough 100 L



FRUIT fermenting barrels

Whether you're making small amounts of brandy at home, you'll need food-grade barrel to ferment and age it in.

EQUIPMENT:

- Fermenting barrel
- Bucket Lid (with hole for airlock)
- Airlock
- outlet spigot

ADVANTAGES

- Plastic is a durable, versatile option for fermenting, and can range from inexpensive fermenting buckets to more advanced versions with additional features.
- Fermenting barrels are great to keep around for overflow situations when you need additional fermenter space in a hurry, because you can nest them to take up less space than other types of fermenters.
- They also have wide openings, which is convenient when working with fruit (i.e., adding additional, whole fruit like tart cherries to a juice fermentation).
- Additional features such as an outlet spigot above where the lees (sediment) collect which allows you to transfer juice without using a siphon (racking cane).
- The spigot saves a lot of time,
- barrels are easy to clean,
- barrels have a opening which makes working with whole fruit more convenient.
- Safe Material: barrels are made from food-grade plastic, high-density polyethylene (HDPE).

Instructions for preparing pomace

The fruit should be fully ripe, as that is when it contains the most sugar and pleasant smells. Crush the apples and pears. Squeeze the plums, peaches, and cherries into a bowl. The temperature needs to be between 15°C and 25°C for the yeast bacteria to

cause alcoholic fermentation. It is important that during the fermentation the container with the fruit is closed, so that air cannot flow in. The CO₂ that is produced by fermentation needs to get out. We recommend to install a fermentation accelerator on the lid.



Certificate for food contact material



FRUIT fermenting barrels





FRUIT fermentation barrel

The durable polyethylene rectangular barrels are suitable for transport and storage of grapes and fruit. Reinforced edge of the barrel allows it to install a mill to grind fruit. The bottom of the barrel can also be a pallet shape, which allows transport with a forklift. The barrels with a lower height can be used also for collecting cider under the press. Rectangular barrels take up little space and can be stacked one into another.

Product	Code	EAN Code	Size [mm]
25 L	2100064220	3830010989517	300 × 430
60 L	2100064250	3830010988770	500 × 500
120 L	2100064590	3830010980132	500 × 700
160 L	2100064240	3830010988787	500 × 870
230 L	2100064440	3830010981986	Ø600 × 980



2100064220 Fruit barrel 25 L 2100064250 Fruit barrel 60 L 2100064590 Fruit barrel 120 L 2100064240 Fruit barrel 160 L 2100064440 Fruit barrel 230 L



FRUIT mash barrel

Barrels for fruits are made of polyethylene. They have a waterproof cover, carrying handles and reinforced ribs. On the cover you can also installed boiling tub. Nice big screw on lid gives an airtight fit. An easy way to ferment large batches.

Product	Code	EAN Code	Size [mm]
30 L	2100096200	3831116113172	360 × 400
55 L	2100096210	3831116113189	400 × 600
80 L	2100096220	3831116113196	400 × 750
130 L	2100096100	3831116113141	550 × 650
170 L	2100096110	3831116113158	580 × 840
240 L	2100096120	3831116113165	550 × 1030



2100096200 Barrel for fruit mash 30 L 2100096210 Barrel for fruit mash 55 L 2100096220 Barrel for fruit mash 80 L 2100096100 Brandy barrel 130 L 2100096110 Brandy barrel 170 L 2100096120 Brandy barrel 240 L



COLLECTION baskets

Advantages of Polyethylene trays:

- lightweight
- easy in use and self assembly
- simple to clean
- durable (wallthickness 3-6 mm)
- solid
- stabilized against UV rays and frost
- 100% recycle after the use

Product	Code	EAN Code	Size [mm]
Collection box 20 L	2100065750	3830050770571	640 × 340 × 220
Collection box 45 L	2100065600	3830010982211	470 × 290 × 230
Basket 15 L	2101005060	3858883812206	Ø425 × 215
Basket 30 L	2100064840	3830010980101	Ø450 × 300
Basket 40 L	2100064850	3830010981979	Ø530 × 510



2100065750
Collection box 20 L for fruit

2100065600
Collection box 45 L for fruit



2101005060
Basket 15 L

2100064840
Basket 30 L

2100064850
Basket 40 L



MEAT trays





MEAT trays

Durable polyethylene trays are suitable for desalination, transportation and storage of meat. Conical square trays take up little space. That is because they be stack one in or on another. Trays are made of polyethylene and are very durable.

Product	Code	EAN Code	Size [mm]
A 20 L	2102014010	3858883813050	570 × 370 × 170
A 30 L	2100064580	3830010981443	400 × 600 × 200
A 50 L	2102015010	3858883813081	780 × 470 × 210
A 60 L	2100064690	3830010981450	800 × 470 × 220
A 70 L	2100064570	3830010981467	800 × 440 × 270
A 80 L	2100064530	3830010984536	900 × 450 × 300
A 85 L	2102008010	3858883811179	855 × 480 × 280
A 90 L	2102011010	3858883810516	810 × 400 × 380
A 100 L	2102006210	3858883817270	840 × 605 × 340
A 130 L	2102019010	3858883812893	780 × 495 × 355
A 150 L	2102007210	3858883817836	850 × 625 × 440



MEAT trays

Durable polyethylene trays are suitable for desalination, transportation and storage of meat. Conical square trays take up little space. That is because they be stored one in or on another. Oval trays also have lids. Trays are made of polyethylene and are very durable and resistant to blows.

Product	Code	EAN Code	Size [mm]
MVR 30 L	2102004010	3858883810905	680 × 430 × 190
MVR 35 L	2100064660	3830010986462	540 × 400 × 290
MVR 40 L	2102016010	3858883813135	615 × 395 × 300
MVR 40 L	2102002010	3858883811421	570 × 430 × 300
MVR 50 L	2102015010	3858883813081	780 × 470 × 210
MVR 50 L	2100064510	3830010982105	610 × 500 × 240
MVR 70 L	2102003010	3858883810844	750 × 480 × 310





MEAT trays

Durable polyethylene trays are suitable for desalination, transportation and storage of meat. Conical square trays take up little space. That is because they be stored one in or on another. Trays are made of polyethylene and are very durable and resistant to blows.

Volume [L]	Code	EAN Code	Size [mm]
SU 30 L	2102314010	3858883812626	530 × 300 × 270
SU 35 L	2102301210	3858883817058	540 × 440 × 305
SU 40 L	2102315010	3858883815702	530 × 380 × 270
SU 60 L	2100064520	3830010993379	670 × 490 × 320
SU 65 L	2102310010	3858883811803	680 × 500 × 275
SU 70 L	2102317610	3858883818259	875 × 455 × 224
SU 120 L	2100064550	3830010982136	1060 × 500 × 300
SU 180 L	2100064560	3830010982143	1100 × 500 × 460
SU 300 L	2102304010	3858883811100	960 × 720 × 735



2102314010 Tray SU 30 L 2102301210 Tray SU 35 L 2102315010 Tray SU 40 L 2100064520 Tray SU 60 L 2102310010 Tray SU 65 L 2102317610 Tray SU 70 L



2100064550 Tray SU 120 L 2100064560 Tray SU 180 L 2102304010 Tray SU 300 L



BUTCHERY trays

ROTO trays are produced in a rotation moulding process made of high quality polyethylene. They have a high wall thickness. The standard color of the trays is clear white. Tubs are made for food safe.

Product	Code	EAN Code	Size [mm]
Tray for meat ** with cover PWA090	2100513260	3830043919086	730 × 520 × 420
Tray for meat ** with cover PWA180	2100513280	3830050774050	1050 × 610 × 430
Tray for meat 50 L MVO	2100063090	3830050770595	700 × 570
Tray for meat 100 L MVO with cover	2100064410	3830010982129	900 × 600 × 300
Tray for steam the meat	*2100514250	3830043919178	1200 × 450 × 300



2100063090 Tray for meat 50 L 2100064410 Tray for meat 100 L



2100514250 Tray for steam the meat



Product	Code	EAN Code	Size [mm]
Kitchen container 22 L	2102022010	3858883813166	500 × 400 × 170
Kitchen container 40 L	2102023010	3858883813227	500 × 400 × 340
Kitchen container 45 L	2100513190	3830043919079	375 × 375 × 380
Kitchen container 165 L	2100513260	3830043919086	725 × 520 × 420
Kitchen container 70 L	2101228060	3858883811322	430 × 380 × 600
Kitchen container 110 L	2101231060	3858883816273	500 × 420 × 660
Kitchen container 60 L	2101303020	3858883812251	400 × 400 × 550
Kitchen container 110 L	2101315020	3858883812114	Ø470 × 690
Milk cooler	2100065720	3830010985793	500 × 500 × 700

KITCHEN container



2102022010 Kitchen container 22 L 2102023010 Kitchen container 40 L 2100513190 Kitchen container 45 L 2100513260 Kitchen container 165 L



2101228060 Kitchen container 70 L 2101231060 Kitchen container 110 L 2101303020 Kitchen container 60 L 2101315020 Kitchen container 110 L 2100065720 Milk cooler

Product	Code	EAN Code	Size [mm]
Trolley 130 L	2100525700	3830043919376	780 × 575 × 835
Trolley 180 L	2100525090	3830043919321	1070 × 570 × 835
Trolley 190 L	2100525320	3830043919338	1070 × 570 × 835
Trolley 270 L	2100525040	3830043919314	825 × 645 × 830
Trolley 500 L	2100525340	3830043919345	1430 × 820 × 960
Mix trolley 150 L	2100513200	3830043917471	1300 × 680 × 340
Frame for trolley M150 L - RF	2170016770	3830043919260	1300 × 680 × 340
Frame for trolley M150 L - ZN	2100516760	3830043919260	1300 × 680 × 340

TRANSPORT trolley

Durable polyethylene trolleys are suitable for desalination, transportation and storage of meat. Tapering square trolley take up little space and can put together one in another or one on another. Oval trolley have a plastic cover.



2100513200 Mix trolley 150 L 2100525090 Trolley 180 L 2100525320 Trolley 190 L



2100525700 Trolley 130 L 2100525040 Trolley 270 L 2100525340 Trolley 500 L



roto
since 1974

WORLDWIDE ROTOMOULDER

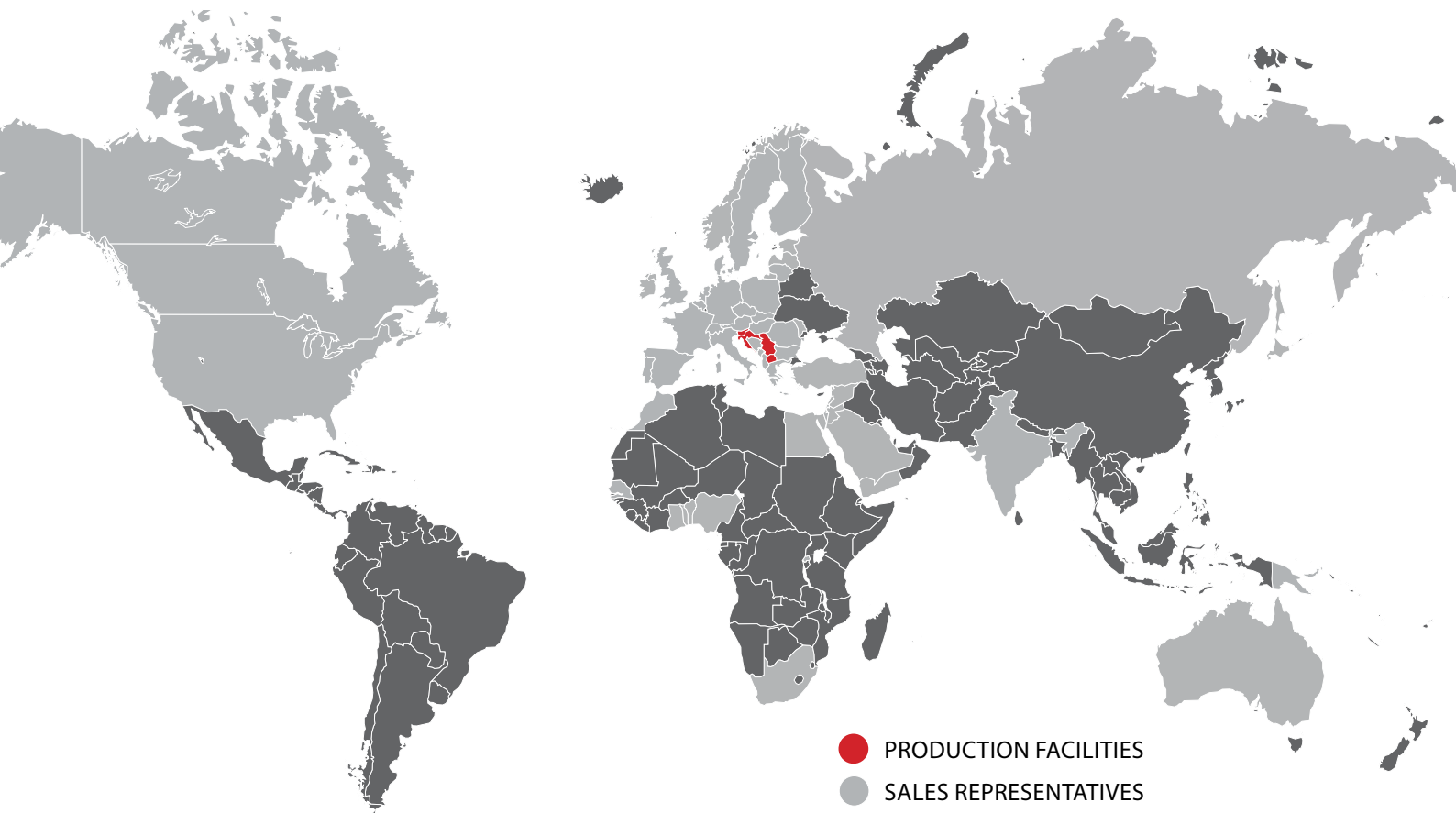

Catalogue 2018



www.roto-group.eu

ROTO

tel: +386 (0)2 52 52 175

fax: +386 (0)2 52 52 161

agri@roto.si